

MACKE®

S410s PASSIVE SUBWOOFER USER'S MANUAL

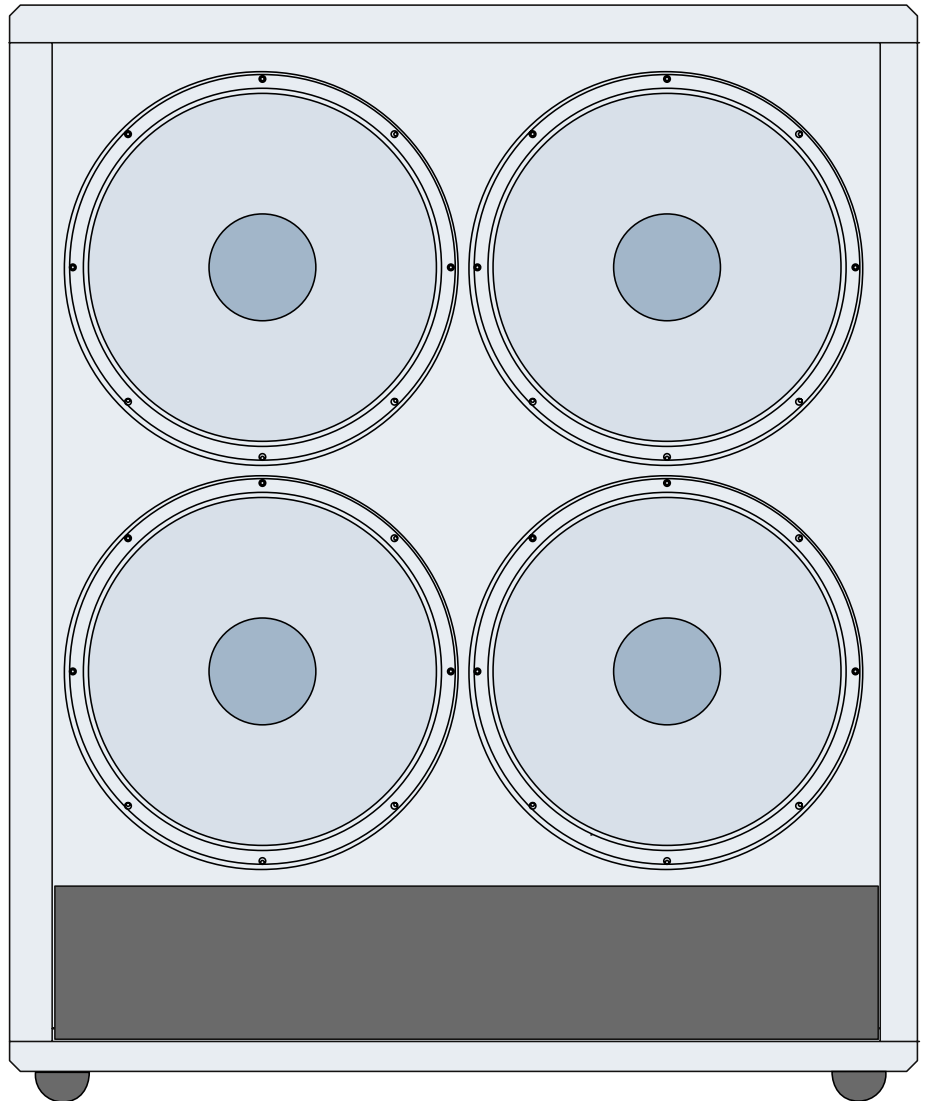

IMPORTANT SAFETY INSTRUCTIONS

1. Read these instructions.
2. Keep these instructions.
3. Heed all warnings.
4. Follow all instructions.
5. Do not use this apparatus near water.
6. Clean only with dry cloth.
7. Do not block any ventilation openings. Install in accordance with the manufacturer's instructions.
8. Do not install near any heat sources such as radiators, heat registers, stoves, or other apparatus (including amplifiers) that produce heat.
9. Only use attachments/accessories specified by the manufacturer.
10. Use only with a cart, stand, tripod, bracket, or table specified by the manufacturer, or sold with the apparatus. When a cart is used, use caution when moving the cart/apparatus combination to avoid injury from tip-over.

11. Refer all servicing to qualified service personnel. Servicing is required when the apparatus has been damaged in any way, such as power-supply cord or plug is damaged, liquid has been spilled or objects have fallen into the apparatus, the apparatus has been exposed to rain or moisture, does not operate normally, or has been dropped.
12. Exposure to extremely high noise levels may cause permanent hearing loss. Individuals vary considerably in susceptibility to noise-induced hearing loss, but nearly everyone will lose some hearing if exposed to sufficiently intense noise for a period of time. The U.S. Government's Occupational Safety and Health Administration (OSHA) has specified the permissible noise level exposures shown in the following chart.

According to OSHA, any exposure in excess of these permissible limits could result in some hearing loss. To ensure against potentially dangerous exposure to high sound pressure levels, it is recommended that all persons exposed to equipment capable of producing high sound pressure levels use hearing protectors while the equipment is in operation. Ear plugs or protectors in the ear canals or over the ears must be worn when operating the equipment in order to prevent permanent hearing loss if exposure is in excess of the limits set forth here.

PORTABLE CART WARNING



Carts and stands - The Component should be used only with a cart or stand that is recommended by the manufacturer. A Component and cart combination should be moved with care. Quick stops, excessive force, and uneven surfaces may cause the Component and cart combination to overturn.

Duration Per Day In Hours	Sound Level dBA, Slow Response	Typical Example
8	90	Duo in small club
6	92	
4	95	Subway Train
3	97	
2	100	Very loud classical music
1.5	102	
1	105	Tami screaming at Adrian about deadlines
0.5	110	
0.25 or less	115	Loudest parts at a rock concert

WARNING — To reduce the risk of fire or electric shock, do not expose this apparatus to rain or moisture.

INTRODUCTION

Thank you for choosing the Mackie S410s sound reinforcement subwoofer.

The S410s is a professional passive subwoofer, designed to complement our professional line of passive and active loudspeakers, powered mixers, and power amplifiers. It is capable of extremely high sound-pressure levels, and designed to give you the best performance of any subwoofer in its class and price range.

The S410s features four 10-inch high-power low-frequency woofers in a bass-reflex designed cabinet. Using four smaller drivers rather than one large 15" driver has several advantages.

- Smaller drivers provide better transient response for a “punchier” sound.
- Four 10" drivers provide more surface area than a single 15" driver to move more air.
- The quad-driver configuration provides better power handling and improved efficiency over a single 15" driver.

The woofers incorporate technology used in large-format touring systems and are virtually indestructible.

Connecting and setting up the S410s is a breeze. It accepts a speaker-level signal via a Neutrik Speakon® connector and has a second Speakon connector for daisy-chaining the signal to another speaker. The built-in 180 Hz low-pass filter allows you to connect a full-range signal directly to the input of the subwoofer.

The cabinet is constructed using 18 mm multi-layer birch plywood. A carrying handle is integrated into each side for easy loading and transport, and optional casters can be installed on the back of the cabinet for even easier transport.

Contents

IMPORTANT SAFETY INSTRUCTIONS	2
INTRODUCTION	3
HOOKUP DIAGRAMS	4
Quick-Start	4
CONNECTIONS	6
PLACEMENT	6
Room Acoustics	6
SERVICE INFORMATION	8
Warranty Service	8
Troubleshooting	8
Repair	8
CARE AND MAINTENANCE	9
S410s SPECIFICATIONS	9
S410s LIMITED WARRANTY	11

Don't forget to visit our website at www.mackie.com
for more information about this and other Mackie products.

HOOKUP DIAGRAMS

Quick-Start

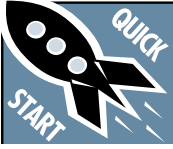

Make all initial connections with the power switches OFF on all equipment. Make sure all master volume, level, or gain controls are all the way down.

1. Connect the line-level outputs from your mixing console (or other signal source) to the inputs of your power amplifier.
2. Connect the “Speaker Output” from your power amplifier (or powered mixer) to the INPUT connector on the S410s.
3. Turn on your mixing console (or other signal source).
4. Turn on the amplifier. Turn up its volume or gain control(s) as recommended by the manufacturer.
5. Start the signal source, whether it be speaking into a microphone or starting a CD player. Adjust the volume controls on the mixer (or other signal source) for normal operation.

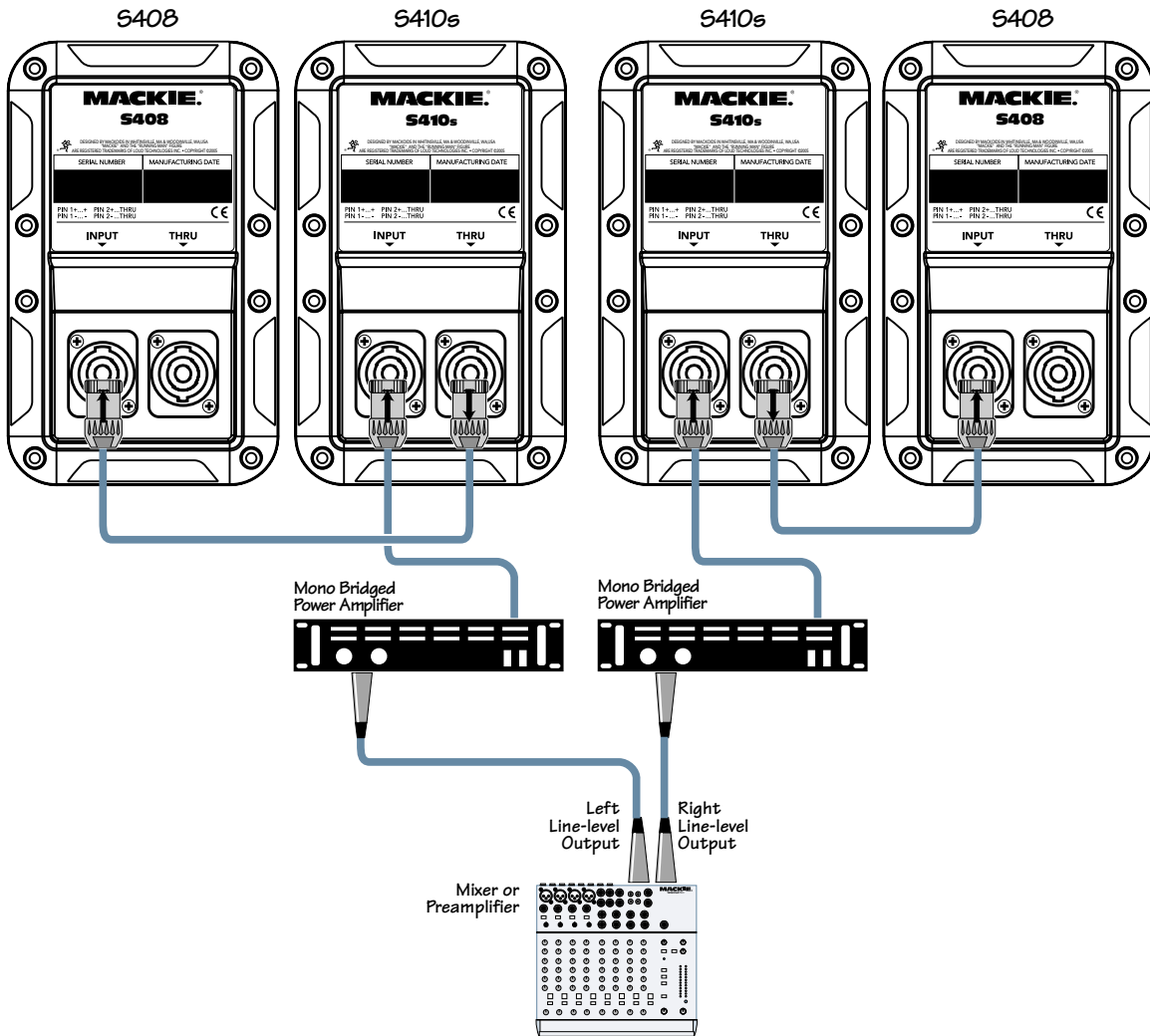

S410s AND S408: WITH A MIXER AND TWO POWER AMPLIFIERS

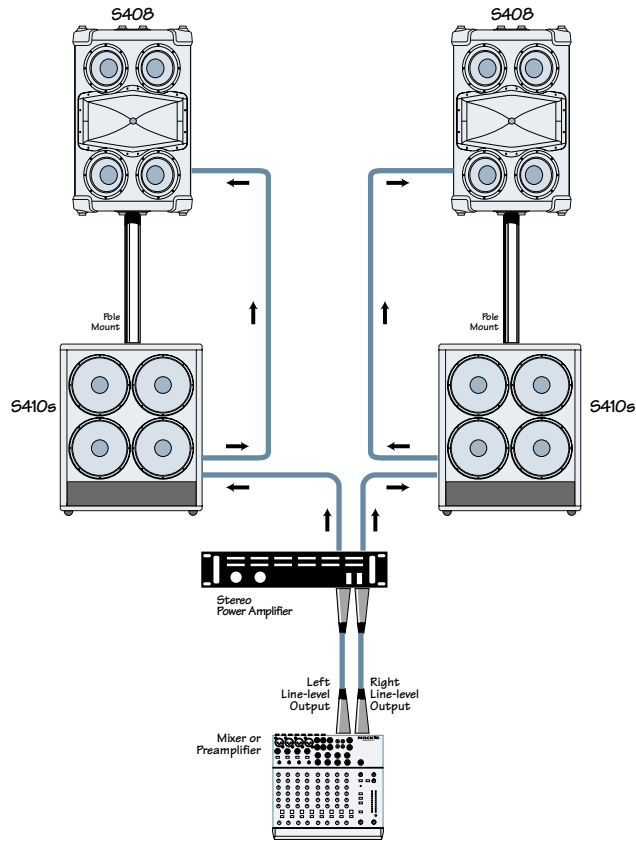

S410s AND S408: WITH A MIXER AND POWER AMPLIFIER

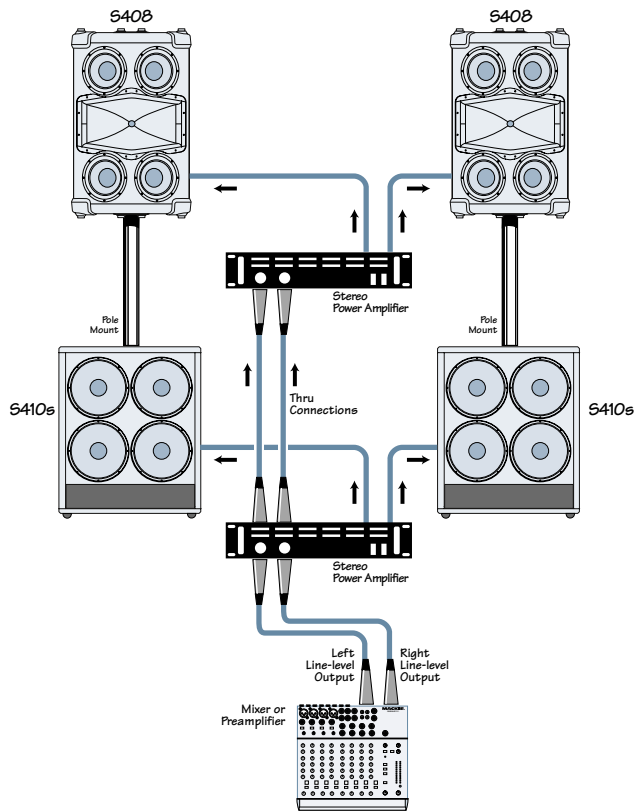

S410s AND S408: WITH A MIXER AND TWO POWER AMPLIFIERS

CONNECTIONS

The S410s has two connectors labeled INPUT and THRU. These are both Neutrik Speakon™ connectors, which provide a secure and reliable connection for loudspeakers and subwoofers. These connectors are wired in parallel, and allow for connecting the input signal to another speaker's input.



NEVER connect more than one output from a power amplifier to the S410s INPUT or THRU connectors.

Keep in mind, when connecting two or more speakers in parallel using the “thru” connections, that you want to avoid going below the minimum impedance requirements for your power amplifier.



The S410s has a nominal impedance of 8 ohms.
Two 8 ohm cabinets in parallel equals 4 ohms.
Three 8 ohm cabinets in parallel equals 2.7 ohms.
Four 8 ohm cabinets in parallel equals 2 ohms.

Use high-quality speaker cable as recommended by the power amplifier manufacturer.



DO NOT use coaxial shielded cable like a guitar cord to make speaker connections. They are not designed to handle the high currents required to drive a loudspeaker.

The Speakon connector is wired as follows:
Pin 1+ = Signal (“+” or hot)
Pin 1- = Ground (“-” or cold)

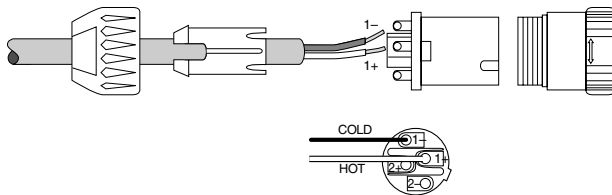

Speakon Connectors

PLACEMENT

The S410s subwoofer is designed to sit on the floor or stage. A socket is provided on the top of the cabinet for mounting another speaker on top of the S410s, like the Mackie S408 two-way loudspeaker. Use the optional Mackie speaker mounting pole (SPM100) to mount them on the S410s (see Hookup Diagrams on page 5).



WARNING: The cabinet has no rigging points and is not suitable for rigging. **NEVER** attempt to suspend the S410s by its handles.



As with any powered components, protect them from moisture. If you are setting them up outdoors, make sure they are under cover if you expect rain.

Room Acoustics

The S410s subwoofers are designed to sound as neutral as possible; that is, to reproduce the input signal as accurately as possible.

Room acoustics play a crucial role in the overall performance of a sound system. Here are some additional placement tips to help overcome some typical room problems that might arise:

- Avoid placing loudspeakers in the corners of a room. This increases the low frequency output and can cause the sound to be muddy and indistinct.
- Avoid placing loudspeakers against a wall. This, too, increases the low frequency output, though not as much as corner placement. However, if you do need to reinforce the low frequencies, this is a good way to do it.
- Avoid placing the speakers directly on a hollow stage floor. A hollow stage can resonate at certain frequencies, causing peaks and dips in the frequency response of the room. It's better to place the loudspeakers on a sturdy table or stand designed to handle the weight of the cabinet(s).

- Position the full-range loudspeakers so the high-frequency drivers are 2 to 4 feet above ear level for the audience (make allowances for a standing/dancing in the aisles audience). High frequencies are highly directional and tend to be absorbed much easier than lower frequencies. By providing direct line-of-sight from the loudspeakers to the audience, you increase the overall brightness and intelligibility of the sound system.
- Highly reverberant rooms, like many gymnasiums and auditoriums, are a nightmare for sound system intelligibility. Multiple reflections off the hard walls, ceiling, and floor play havoc with the sound. Depending on the situation, you may be able to take some steps to minimize the reflections, such as putting carpeting on the floors, closing draperies to cover large glass windows, or hanging tapestries or other materials on the walls to absorb some of the sound.

However, in most cases, these remedies are not possible or practical. So what do you do? Making the sound system louder generally doesn't work because the reflections become louder, too. The best approach is to provide as much direct sound coverage to the audience as possible. The farther away you are from the speaker, the more prominent will be the reflected sound.

Use more speakers strategically placed so they are closer to the back of the audience. If the distance between the front and back speakers is more than about 100 feet, you should use a delay processor to time-align the sound. (Since sound travels about 1 foot per millisecond, it takes about 1/10 of a second to travel 100 feet.)

SERVICE INFORMATION

Warranty Service

Details concerning warranty service are spelled out on page 11 of this manual.

If you think your subwoofer has a problem, please do everything you can to confirm it before calling for service, including reading through the following Troubleshooting section. Doing so might save you from being deprived of your Mackie subwoofer.

Of all Mackie products returned for service (which is hardly any at all), many are coded “CND” — Could Not Duplicate—which usually means the problem lay somewhere else in the system. The following troubleshooting tips may sound obvious, but here are some things you can check:

Troubleshooting

No sound

- Are the level controls on the mixer or amplifier turned all the way down? Follow the procedures in the “Quick-Start” section on page 4 to verify that all the volume controls in the system are properly adjusted.
- Is the signal source working (and making union scale)? Make sure the connecting cables are in good repair and securely connected at both ends.
- Make sure the mixer does not have a Mute on or a Processor loop engaged. If you find something like this, make sure the volume/gain is turned down before disengaging the offending switch.

Poor bass performance

- Check the polarity of the connections between the mixer and all the loudspeakers and subwoofers. You may have your positive and negative connections reversed at one end of one cable, causing one loudspeaker to be out-of-phase.

Poor sound

- Is it loud and distorted? Make sure that you're not overdriving a stage in the signal chain. Verify that all level controls are set properly.
- Is the input connector plugged completely into the jack? Make sure all connections are secure. It's a good idea to periodically clean all electrical connections with a non-lubricating electrical contact cleaner.

Repair

Service for Mackie products is available at a factory-authorized service center. Service for Mackie products outside the United States can be obtained through local dealers or distributors.

If your S410s needs service, please follow these instructions:

1. Review the preceding troubleshooting suggestions. Please.
2. Call Tech Support at 1-800-898-3211, 7 am to 5 pm PST, to explain the problem in detail. They will ask you all sorts of impertinent questions in the hope of sorting out the problem. If it appears that the S410s needs repair, you will be given a Service Request Number. Have your subwoofer's serial number ready. *You must have a Service Request Number before you can obtain service at a factory-authorized service center.*
3. Keep this user's manual. We don't need it to repair the subwoofer.
4. *Pack the subwoofer in its original packaging*, including protective wrap, endcaps, and box. *This is VERY IMPORTANT.* When you call for the Service Request Number, please let Tech Support know if you need new packaging. *Mackie is not responsible for any damage that occurs due to non-factory packaging.*
5. Include a legible note stating your name, shipping address (no P.O. boxes), daytime phone number, Service Request Number, and a detailed description of the problem, including how we can duplicate it.
6. Write the Service Request Number in **BIG PRINT** on top of the box. Product shipped without the Service Request Number will be refused.
7. Tech Support will tell you where to ship the subwoofer for repair. We suggest insurance for all forms of cartage.
8. We'll try to fix the subwoofer within five business days. Once it is repaired, we'll ship it back the same way in which it was received. This paragraph does not necessarily apply to non-warranty service.

Note: You must have a sales receipt from an Authorized Mackie Dealer to qualify for a warranty repair.

CARE AND MAINTENANCE

Your Mackie subwoofer will provide many years of reliable service if you follow these guidelines:



Avoid exposing the subwoofer to moisture. If your loudspeakers are set up outdoors, be sure they are under cover if you expect rain.

- Avoid exposure to extreme cold (below freezing temperatures). If you must operate the subwoofers in a cold environment, warm up the voice coil slowly by sending a low-level signal through it for about 15 minutes prior to high-power operation.
- Use a slightly damp cloth with a mild soap solution to clean the cabinets. Only do this when the power is turned off. Avoid getting moisture into any of the openings of the cabinet, particularly where the driver is located.

S410s SPECIFICATIONS

Acoustic Performance

<i>Frequency Range (-10 dB)</i>	40 Hz–400 Hz
<i>Sensitivity</i>	96.3 dB @ 1 W/1 m
<i>Max SPL long-term</i>	131 dB @ 1m
<i>Max SPL peak</i>	134 dB @ 1m
<i>Crossover Point</i>	180 Hz, 12 dB/octave
<i>Woofers Loading</i>	Bass reflex

Input/Output

<i>INPUT/THRU Type</i>	Neutrik Speakon™
<i>Input Impedance (nominal)</i>	8 ohms
<i>Input Impedance (minimum)</i>	3.8 ohms @ 110 Hz
<i>Recommended Lowpass Filter (if using external crossover)</i>	150 Hz, 24 dB/octave
<i>Power Handling</i>	750 watts rms continuous 3000 watts peak

Low-Frequency Section

<i>Woofers Diameter</i>	10.0 in/254 mm
<i>Voice Coil Diameter</i>	2 in/51 mm
<i>Diaphragm Material</i>	Paper
<i>Magnet Material</i>	Ferrite

Construction Features

<i>Basic Design</i>	Bass reflex
<i>Material</i>	18 mm multi-layered plywood
<i>Finish</i>	Black paint
<i>Handles</i>	One on each side
<i>Grille</i>	Perforated metal with weather-resistant coating

Physical Properties

<i>Height</i>	28.0 in/71.1 cm
<i>Width</i>	24.0 in/61.0 cm
<i>Depth</i>	25.0 in/63.5 cm
<i>Weight</i>	95 lb/43.1 kg
<i>Mounting Methods</i>	Floor mount only. The S410s cabinet has no rigging points and is not suitable for flying. <i>Never attempt to suspend the cabinet by its handles.</i>

Options

<i>Casters</i>	Set of four casters for mounting on the rear of the cabinet. See <i>Caster Installation</i> instructions on next page.
----------------	---

Disclaimer

Since we are always striving to make our products better by incorporating new and improved materials, components, and manufacturing methods, we reserve the right to change these specifications at any time without notice.

“Mackie” and the “Running Man” figure are registered trademarks of LOUD Technologies Inc.

All other brand names mentioned are trademarks or registered trademarks of their respective holders, and are hereby acknowledged.

Need Help?

You can reach a technical support representative
Monday through Friday
from 7 AM to 5 PM PST at:

1-800-898-3211

After hours, visit www.mackie.com and click Support,
or email us at: techmail@mackie.com



S410s Frequency Response On-Axis

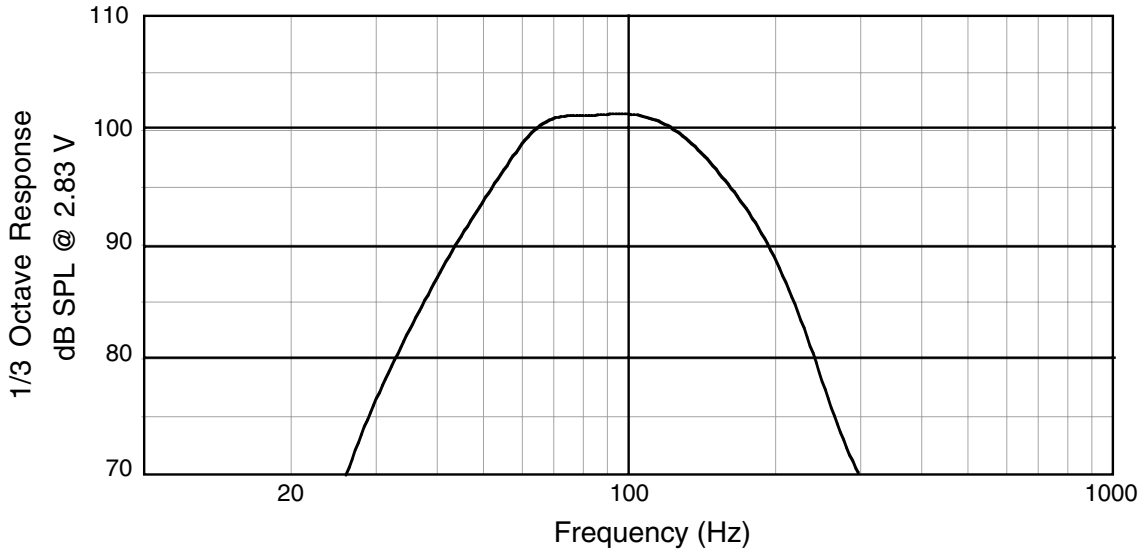

S410s Dimensions

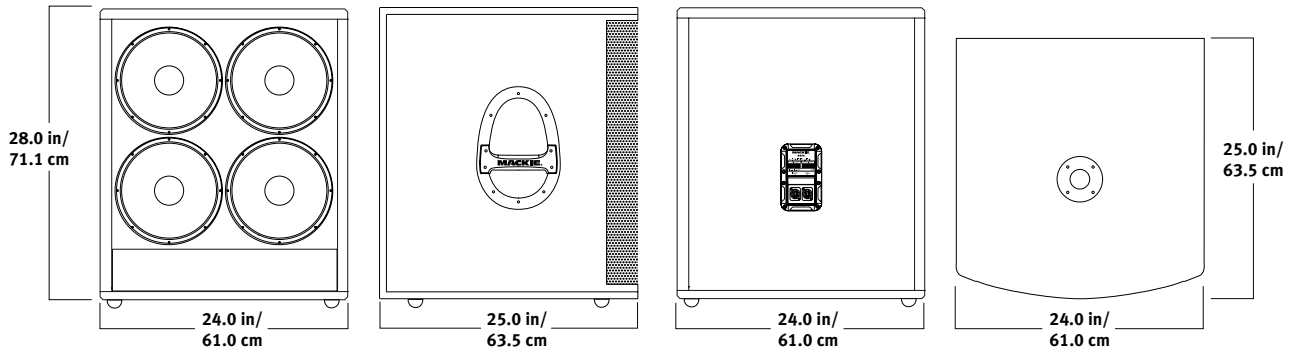

S410s Caster Installation

Parts List	
2	Swivel Casters (150001)
2	Fixed Casters (150007)
16	1/4-20 x 1-1/2" hex bolts (102022)
16	Flat Washers 1/4" 18-8 (105005)
16	Lock Washers 1/4" 18-8 (105004)

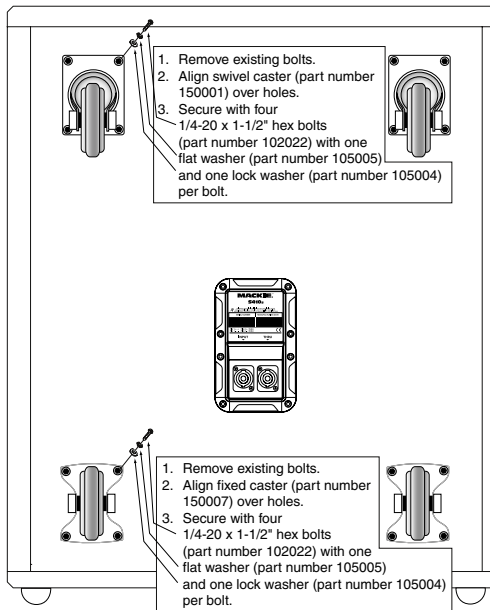

S410s LIMITED WARRANTY

Please keep your sales receipt in a safe place.

A. LOUD Technologies Inc. warrants all materials, workmanship and proper operation of this product for a period of **two years** from the original date of purchase. If any defects are found in the materials or workmanship or if the product fails to function properly during the applicable warranty period, LOUD Technologies, at its option, will repair or replace the product. **This warranty applies only to equipment sold and delivered within the U.S. by LOUD Technologies Inc. or its authorized dealers.**

B. Failure to register online or return the product registration card will not void the two-year warranty.

C. Service and repairs of Mackie products are to be performed **only** at a factory-authorized facility (see D below). Unauthorized service, repairs, or modification will void this warranty. To obtain repairs under warranty, you must have a copy of your sales receipt from the authorized Mackie dealer where you purchased the product. It is necessary to establish purchase date and determine whether your Mackie product is within the warranty period.

D. To obtain factory-authorized service:

1. Call Mackie Technical Support at 800/898-3211, 7 AM to 5 PM Monday through Friday (Pacific Time) to get a Service Request Number. Products returned without a Service Request Number will be refused.
2. Pack the product in its original shipping carton. Also include a note explaining exactly how to duplicate the problem, a copy of the sales receipt with price and date showing, and your return street address (no P.O. boxes or route numbers, please!). If we cannot duplicate the problem or establish the starting date of your Limited Warranty, we may, at our option, charge for service time.
3. Ship the product in its original shipping carton, **freight prepaid** to the authorized service center. The address of your closest authorized service center will be given to you by Technical Support.

IMPORTANT: Make sure that the Service Request Number is plainly written on the shipping carton.

E. LOUD Technologies reserves the right to inspect any products that may be the subject of any warranty claims before repair or replacement is carried out. LOUD Technologies may, at our option, require proof of the original date of purchase in the form of a dated copy of the original dealer's invoice or sales receipt. Final determination of warranty coverage lies solely with LOUD Technologies.

F. Any products returned to one of the LOUD Technologies factory-authorized service centers and deemed eligible for repair or replacement under the terms of this warranty will

be repaired or replaced within thirty days of receipt. LOUD Technologies and its authorized service centers may use refurbished parts for repair or replacement of any product. Products returned to LOUD Technologies that do not meet the terms of this Warranty will be not be repaired unless payment is received for labor, materials, return freight, and insurance. Products repaired under warranty will be returned freight prepaid by LOUD Technologies to any location within the boundaries of the USA.

G. LOUD Technologies warrants all repairs performed for 90 days or for the remainder of the warranty period. This warranty does not extend to damage resulting from improper installation, misuse, neglect or abuse, or to exterior appearance. This warranty is recognized only if the inspection seals and serial number on the unit have not been defaced or removed.

H. LOUD Technologies assumes no responsibility for the quality or timeliness of repairs performed by an authorized service center.

I. This warranty is extended to the original purchaser and to anyone who may subsequently purchase this product within the applicable warranty period. A copy of the original sales receipt is required to obtain warranty repairs.

J. This is your sole warranty. LOUD Technologies does not authorize any third party, including any dealer or sales representative, to assume any liability on behalf of LOUD Technologies or to make any warranty for LOUD Technologies Inc.

K. THE WARRANTY GIVEN ON THIS PAGE IS THE SOLE WARRANTY GIVEN BY LOUD TECHNOLOGIES INC. AND IS IN LIEU OF ALL OTHER WARRANTIES, EXPRESS AND IMPLIED, INCLUDING THE WARRANTIES OF MERCHANTABILITY AND FITNESS FOR A PARTICULAR PURPOSE. THE WARRANTY GIVEN ON THIS PAGE SHALL BE STRICTLY LIMITED IN DURATION TO TWO YEARS FROM THE DATE OF ORIGINAL PURCHASE FROM AN AUTHORIZED MACKIE DEALER. UPON EXPIRATION OF THE APPLICABLE WARRANTY PERIOD, LOUD TECHNOLOGIES INC. SHALL HAVE NO FURTHER WARRANTY OBLIGATION OF ANY KIND. LOUD TECHNOLOGIES INC. SHALL NOT BE LIABLE FOR ANY INCIDENTAL, SPECIAL, OR CONSEQUENTIAL DAMAGES THAT MAY RESULT FROM ANY DEFECT IN THE MACKIE PRODUCT OR ANY WARRANTY CLAIM. Some states do not allow exclusion or limitation of incidental, special, or consequential damages or a limitation on how long warranties last, so some of the above limitations and exclusions may not apply to you. This warranty provides specific legal rights and you may have other rights which vary from state to state.

MACKIE®

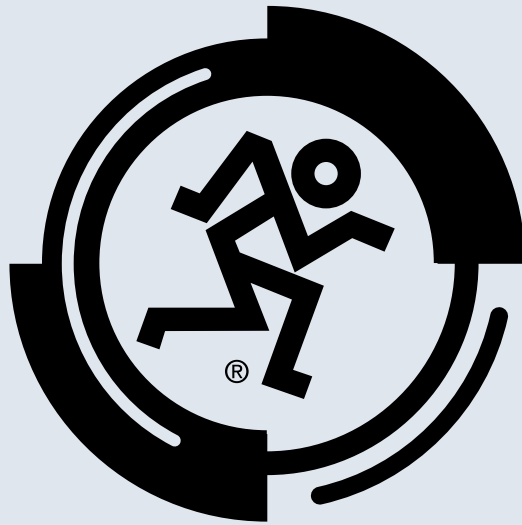

MACKIE.®

16220 Wood-Red Road NE • Woodinville, WA 98072 • USA

US and Canada: 800.898.3211

Europe, Asia, Central and South America: 425.487.4333

Middle East and Africa: 31.20.654.4000

Fax: 425.487.4337 • www.mackie.com

E-mail: sales@mackie.com